

# 3/4 - 16 UNF 316L Stainless Steel Heavy Duty Weld Nut

Model Number: 316M36

Price: \$ 26.38

- Material Type: 316L Stainless Steel
- Finish: Plain
- Classification: Heavy Duty
- Hole Size: 3/4 - 16 UNF
- Stock Diameter: 1 1/2"
- Overall Length: 1 1/2"
- % of Thread Engagement: 108 %

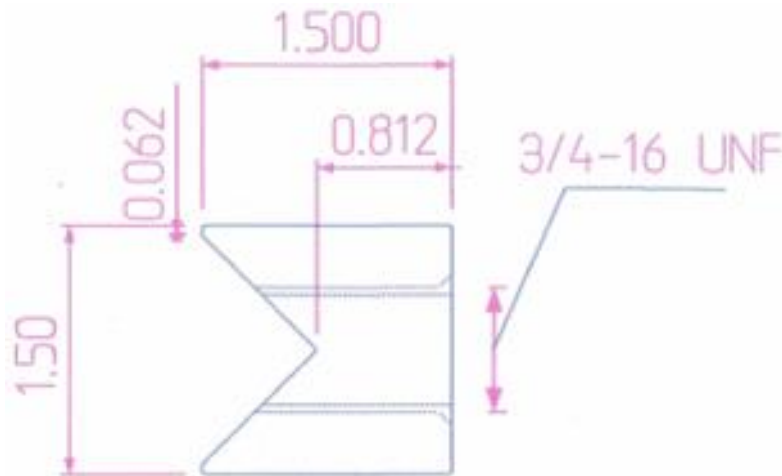

## Kiesler Machine Inc

P.O. Box 357  
13700 S. Martin Mathis Road N.E.  
Palmyra, IN. 47164

## Contact Info :

info@kieslermachine.com  
Toll-Free : 888-565-6610  
Phone : 812-364-6610



Smoother Than The Rest  
- Guaranteed!

Data Provided For Reference Only.

Disclaimer: This drawing is property of Kiesler Machine Inc, Kieslermachine.com. It is owned with the understanding that it will in no way be used in a manner which is harmful to Kiesler Machine Inc.